

Designing fractional order PID for car suspension systems

Saeed Zeraati
islamic azad university gonabad branch IRAN

Abstract: The suspension system of the car has a crucial effect on the comfort of traveling and controlling the vehicle because the body of the car is assembled on it and transfer the forces by the road to the body. In this study the implementation of FOPID controller based on genetic algorithm on the 1/4 active suspension system was investigated through the non-linear hydraulic actuator. The working principle of hydraulic suspension system that sometimes is called hydro-pneumatic is based on the compressibility principles of gases and non-compressibility of liquids. Investigation of the given acceleration to the passengers and deviation of suspension shows that the suggested controlling structure has made more ease for the aboard. The results of simulation of the system regarding a non-flat road as the entrance, proves the ideal operation of closed ring system.

Key words: suspension system of the vehicle, genetic algorithm, hydraulic actuator, FOPID controller

◆

1- Introduction

The need to have a comfort ride and the security of cars has made many car industries to use the active suspension system. Such suspension systems that are controlled by electronic tools, improve the movement quality and its safety. The suspension systems of car are classified into three classes based on quality. The inactive suspension systems in which the pneumatic or hydraulic actuators are used for perfect controlling of vibration of the car [1]. In the active suspension systems the pneumatic or hydraulic actuators are used to have perfect controlling of the amount of car vibration that are put in parallel to the springs and low springs and the suitable strategy is applied using the information from vibration. Four important parameters that should be taken into consideration in designing each suspension system are as follows: the ease of travelling, the movement of body of the automobile, stability on the road, the movement of suspension components of the system.

Of course, no suspension system can optimize all the four mentioned parameters simultaneously. But it provides the ease of the passengers while keeping the stability by creating a compromise among them. It is possible to gain an optimized promise among the parameters in the active suspension system. Designing the active suspension systems of the vehicle is the topic of many modern researches in car industry in the world while the non-linear behavior of hydraulic actuator of the system is not considered. On the other hand, the practical experiments have shown the importance of the non-linear behavior of the actuator in identifying the optimal compromise in the suspension system of the car based on the empirical results [2,3,4] in 1/4 model of vehicle that is

illustrated in figure 1. In this model, only the vertical movement of the body on one wheel is considered and in many cases is used to prove the given controlling strategy [3, 5, 6, and 7].

In [9] a PID controller system is designed for the suspension system of the car. The slide controller mode is designed in [10] for the active suspension. The slide controlling mode is used to weaken the vibration. The active suspension using the information observed previously and controlling the previous model is given in [11]. In this method, the predictor controlling model is expressed by using the previous observed information to control the active suspension systems. Designing MPC considers clearly all the limitations on the modes, control, and output variables.

2- Mathematical premises

In spite of the complexities in fractional calculus, in the recent decades by improvements in chaos areas and the close relationship of fractals with fractional calculus has caused that interest in applying it to be increased. Fractional calculus has a more domain than the integral derivation. If instead of the order of integral derivation, the fractional rank is used the fractional calculus should be used to solve the fractional derivation and integral.

The derivation or integral taker operator is shown by ${}_a D_t^\alpha$. This actuator is a symbol that is used to take the derivation and fractional integral. α is the symbol of derivation for positive numbers and it shows the integral for negative numbers. Definitions that are usually used for fractional derivation are as follows: Granvald-letinkove, Riemann -Liovil, and Caputo and are expressed as follows:

Granvald- Letinkov:

Definition of Granvald- Letinkov is as follows:

$${}_a D_t^\alpha f(t) = \lim_{h \rightarrow 0} h^{-\alpha} \sum_{j=0}^{\lfloor t-\alpha/h \rfloor} (-1)^j \binom{\alpha}{j} f(t-jh), \quad (1)$$

The upper limit sum, in the above equation should go toward the infinity and $\frac{t-a}{h}$ has this quality (a, t are the upper and down limits of the derivation taking).

The formula of Granvald- Letinkov can be used to take the fractional integral.

The simplest change for using this formula in taking the integral is using it for

$\alpha < 0$. In this mode, we should make $\binom{-\alpha}{m}$ definable by gamma (γ) function.

Definition of Riemann–Liovil [8] second definition is definition of RL that is used as the simplest and easiest definition and is as follows:

$${}_a D_t^\alpha f(t) = \frac{1}{\Gamma(n-\alpha)} \frac{d^n}{dt^n} \int_a^t \frac{f(\tau)}{(t-\tau)^{\alpha-n+1}} d\tau, \quad (2)$$

That $n-1 < \alpha < n$, and also $\Gamma(\cdot)$ is the famous γ function. Its lapillus transformation is as follows:

$$\int_0^\infty e^{-st} {}_0 D_t^\alpha f(t) dt = s^{-\alpha} F(s) \quad \alpha \leq 0$$

$$\int_0^\infty e^{-st} {}_0 D_t^\alpha f(t) dt = s^{-\alpha} F(s) - \sum_{k=0}^{n-1} s^k {}_0 D_t^{\alpha-k-1} f(t) |_{t=0} \quad n-1 < \alpha \leq n \in \mathbb{N} \quad (3)$$

3- Description of the model

The model of suspension system using the method of Newton- Oilier has been defined as follows [3.5].

$$M_s \ddot{Z}_s = -K_s(Z_s - Z_u) - B_s(\dot{Z}_s - \dot{Z}_u) + F_A - F_f \quad (4)$$

$$M_s \ddot{Z}_s = -K_s(Z_s - Z_u) + F_f + B_s(\dot{Z}_s - \dot{Z}_u) - K_t(Z_u - Z_r) - F_A \quad (5)$$

In which:

Z_r : the turbulent input of the road

F_A : the hydraulic actuator power

F_f : friction power of hydraulic actuator

U: the input

In this model, M_s is the mass of a quarter of the body; M_u is the mass of a wheel and its suspension tools. The wheel of the automobile is modeled as a spring with the coefficient of K_t and it is supposed that its attenuation is little. The element of power generator is considered as a hydraulic actuator in active suspension system. This element causes the compensation of chaos resulted from unevenness of the road by creating a changing power. Movement of needle valve is controlled by a bladed valve with a direct current. Based on the researches,

The dynamic of servo valve that includes bladed and needle-like valve has in fact three poles resulted from hydraulic, mechanic and electric systems. However the dominant pole of the system is related to its hydraulic system and consequently is modeled after a number one system that is realized by experiments.

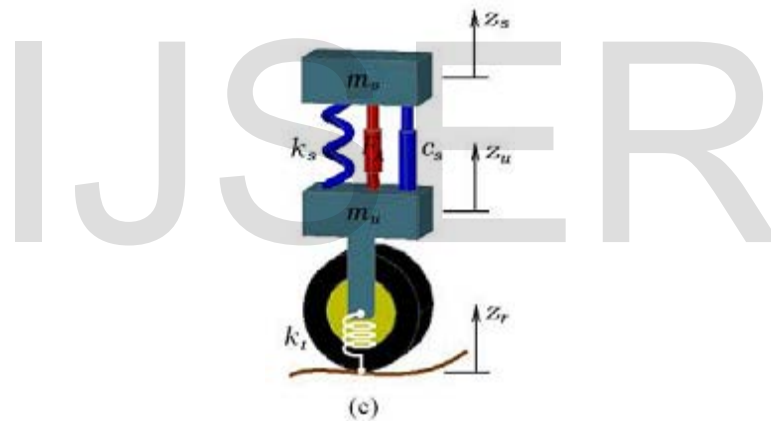

Figure 1. 1/4 suspension system of vehicle

The non-linear relationship between movement of bladed valve and the power of operator is given in equation (6) [7].

$$F = P_l \cdot A \quad (6)$$

The non-linear relations in hydraulic actuator are given in equations (7) to (9).

$$\frac{V_t}{4\beta_e} \dot{P}_l = Q_l - C_{tm} P_l - A(\dot{Z}_s - \dot{Z}_u) \quad (7)$$

$$Q_l - C_{d\omega x_v} \sqrt{\frac{P_s - \text{sgn}(x_v) P_l}{\rho}} \quad (8)$$

$$F_A = Aa \left[C_{d\omega x_v} \sqrt{\frac{P_s - \text{sgn}(x_v)P_l}{\rho}} - C_{tm}P_l - A(\dot{Z}_s - \dot{Z}_u) \right] \quad (9)$$

The friction power of the actuator is considerable and is modeled empirically with the curve of speed according to a homogenous approximation from Signum function and the relations are expressed in (10) and (11).

$$i_f |\dot{Z}_s - \dot{Z}_u| > 0.01 \frac{m}{s} \text{ then } F_f = \mu \text{sgn}(\dot{Z}_s - \dot{Z}_u) \quad (10)$$

$$i_f |\dot{Z}_s - \dot{Z}_u| < 0.01 \frac{m}{s} \text{ then } F_f = \mu \text{sgn} \left(\frac{\dot{Z}_s - \dot{Z}_u \pi}{0.01 \cdot 2} \right) \quad (11)$$

To apply the controlling methods it is necessary to extract the mode space model of the system or the transferring function that is dominant on it. The mode space model of the system is given here. It should be noted that system output here is the acceleration of the body of the vehicle. So the mode variables are selected as equations (12) to (16).

$$x_1 = Z_s - Z_u \quad (12)$$

$$x_2 = \dot{Z}_s \quad (10)$$

$$x_3 = Z_u - Z_r \quad (13)$$

$$x_4 = \dot{Z}_u \quad (14)$$

$$x_5 = P_1 - P_2 \quad (15)$$

$$x_6 = x_v \quad (16)$$

And the equations of system mode are shown as equations (17) to (23).

$$\dot{x}_1 = x_2 - x_4 \quad (17)$$

$$\dot{x}_2 = \frac{1}{M_s} (-K_s x_1 - B_s(x_2 - x_4) + Ax_5 - F_f) \quad (18)$$

$$\dot{x}_3 = x_4 - \dot{z}_4 \quad (19)$$

$$\dot{x}_4 = \frac{1}{M_u} (K_s x_1 - B_s(x_2 - x_4) - K_t x_3 - Ax_5 - F_f) \quad (20)$$

$$\dot{x}_5 = -Bx_5 - \alpha A(x_2 - x_4) + \gamma x_6 \sqrt{p_s - \text{sgn}(x_6)x_5} \quad (21)$$

$$\dot{x}_6 = \frac{1}{\tau} (-x_6 + u) \quad (22)$$

$$y = Ax_5 - F_f \quad (23)$$

The amounts of system parameters are also shown empirically in table 1.

Parameters	Symbols	Quantities
------------	---------	------------

Borty mass	m_s	290kg
Wheel mass	m_u	59kg
Stiffness of the body	K_s	16kN/m
Stiffness of the wheel	K_t	19kN/m
Stiffness of the damper	B_s	1kN.s/m
Area of piston	A	$3359e^4 m^2$
Supply pressure	P_s	10342500 pa
$4\beta/V_1$	A	$4515e^{13} N/m^5$
ac_{tm}	B	1.00
$ac_d W$	γ	$1549e^9 NL(m^{\frac{5}{2}} kg^{\frac{1}{2}})$

Table 1.The numerical amounts of system parameters.

Definitions of parameters used in the system:

Hydraulic fluid density= ρ

The entrance of servo valve = U

Operator volume= V_t

Subsidence coefficient= C_{tm}

Discharge coefficient= C_d

The width of controller valve= W

Pressure of the source= P_s

Integral PID controlling structure is as a family of fractional controllers that can be extended. These structures with transforming function of H(s) are as table 2:

Table2: the controlling structure of PID of fractional order

$H_1(s) = K_p + K_i s^{-1} + K_d s$	کنترل کننده مرتبه صحیح (IOPID) یا کنترل کننده PID
$H_2(s) = K_p + K_i s^{-\lambda}$	کنترل کننده PI مرتبه کسری (FOPI)
$H_3(s) = (K_p + K_i s^{-1})^\lambda$	کنترل کننده مرتبه کسری PI(FO(PID))
$H_4(s) = (k_p + k_d s)^\lambda$	کنترل کننده مرتبه کسری (FO(PD)) PD
$H_4(s) = (K_p + K_i s^{-1} + K_d s)^\lambda$	کنترل کننده مرتبه کسری PID (FO(PID))
$H_5(s) = K_p + K_i s^{-\lambda} + K_d s^\mu$	کنترل کننده PID مرتبه کسری FOPID یا $PI^\lambda D^\mu$

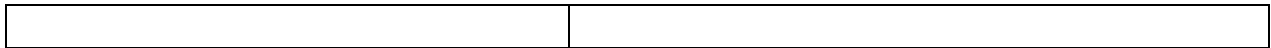

Figure 2 (a) shows that designer is only devoted to designing 4 kinds of controllers PID, PD, PI, P while regarding figure(b), with changing the amount of integral taking (λ) and the amount of taking derivation (μ) between 0 and 1 it is possible to design fractional controllers $PI^\lambda D^\mu$ in addition to designing integral controllers.

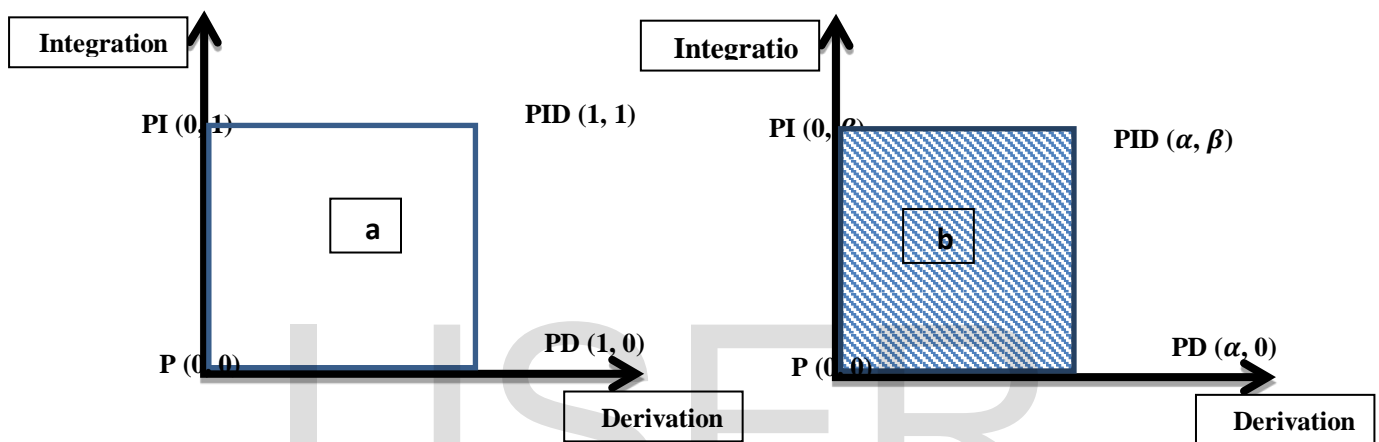

Figure2: Integer and fractional order controllers.

Although PID controllers of integer orders are applied widely in industry, but these controllers don't have a high performance needed for high ranking systems and also fractional systems. So, using fractional controllers in industry is a very new field of research.

4- Designing FOPID controller based on genetic algorithm

Genetic algorithm (GA) is used for optimizing the controller in this study because it has the tendency to whole optimizing and the ability to solve unequal conditions. GA algorithm is briefly described in the following part:

All the independent variables are considered as chromosomes. To create these variables as chromosomes binary bits are used and the length of these bits depending on the needed carefulness can be 32, 16, or 8. In this article variables K_p , K_d and K_i of fractional derivation and fractional integral derivation are given codes as independent variables through binary bits. A new evaluation function

(Fitness) is applied to evaluate the performance of the threads. In this article relation (24) is considered as the evaluation function that should be maximum.

$$\text{Fitness} = \int e(t)^2 dt \quad (24)$$

Genetic algorithm is established based on three actions of intersection genetic, mutation and selection that a set of chromosomes have made a population and these performances are done on them:

Intersection: in this phase, two points are selected randomly so that the present thread is divided into three different parts. Then both threads are considered as a group and their second parts are displaced. This action in each group is done at a percentage of possibility that the intersection coefficient in this article is 0.8.

Mutation: in this part, each bit of the thread is changed in the position at 1% probability that is considered 0.06 in this article to escape the local optimization.

Selection: at first, an initial population is made accidentally. The level of competence is calculated for all the members of this population and regarding their competence of individuals the parents are chosen for the next generation. Choosing the parents for next generation is done based on their competences in different ways. These stages are shown in figure 3. In figure 4, the scheme of an optimizing controller with PSO algorithm is shown.

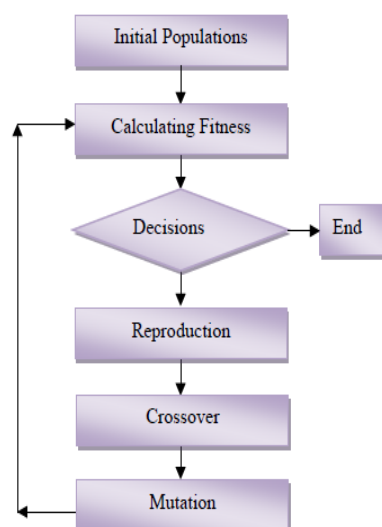

Figure3: the block of genetic algorithm diagram

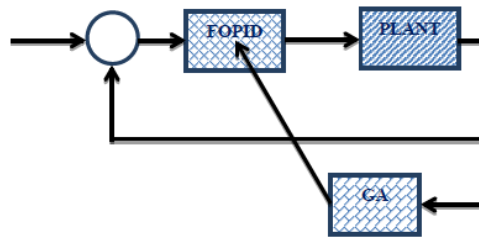

Figure4. Controller optimizing of fractional order with genetic algorithm.

5- **Simulation:** in figure 5 the suspension system simu-link is observed. This simulated model is in the issue with controller of fractional order. PID

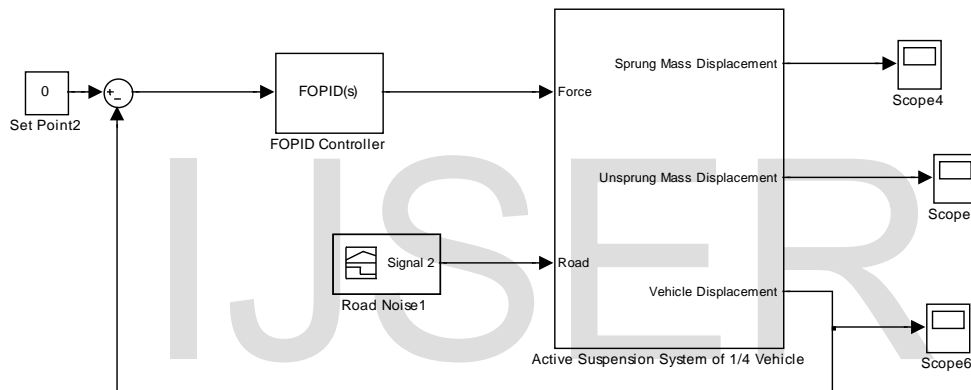

Figure5: simulation of 1/4 suspension system in vehicle

In figure6, the road entrance that is considered an uneven road is seen. The road entrance has both ups and downs. The road has ups t seconds 2 and 6 and it has down at second 4.

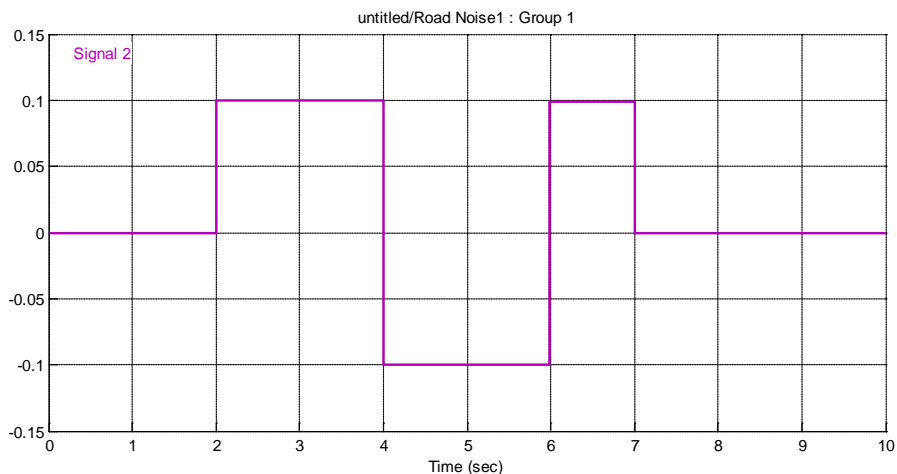

Fig.6. the road noise

It is clear that the gained results that are obtained based on the amounts at table 2 for the controller FOIPD could provide the safety and comfort to a large extent.

	k_p	k_i	k_d	v_i	v_d
FOPID parameter	1.0147	1.7723	9.2305	0.2433	0.9337

As it is seen in figures 7 and 8, the controller could reduce the displacement of suspension system of the body of the car to more than half.

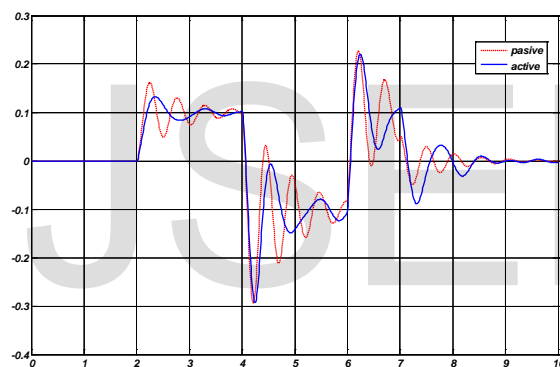

Fig. 7: Displacement of the vehicle

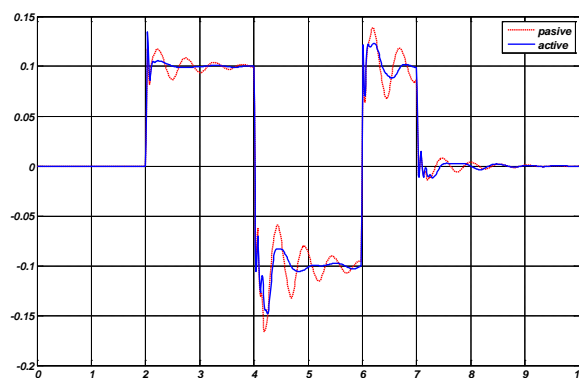

Fig. 8: Displacement of the body

In figure 9, displacement of the wheels of the vehicle is shown in two modes of without control and PID controller. It is seen that this controller could reduce the fluctuations of the wheel as well.

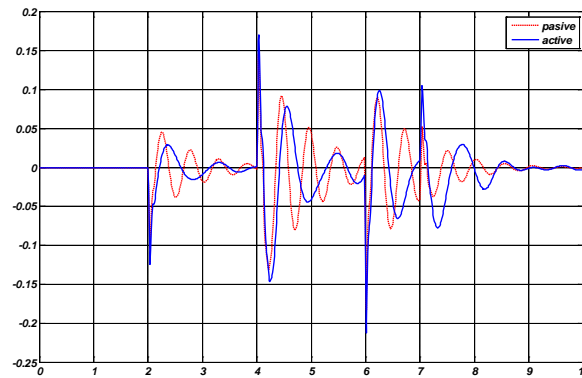

Fig. 9: Displacement of the wheel

The uncertainty is created in this stage.

The uncertainty of the mass is considered as follows:

$$M_{SR} = m_{SR} + \Delta m_{SR}$$

$$M_{WR} = m_{WR} + \Delta m_{WR}$$

The uncertainty is 10% and is considered for M_{SR} and M_{WR} .

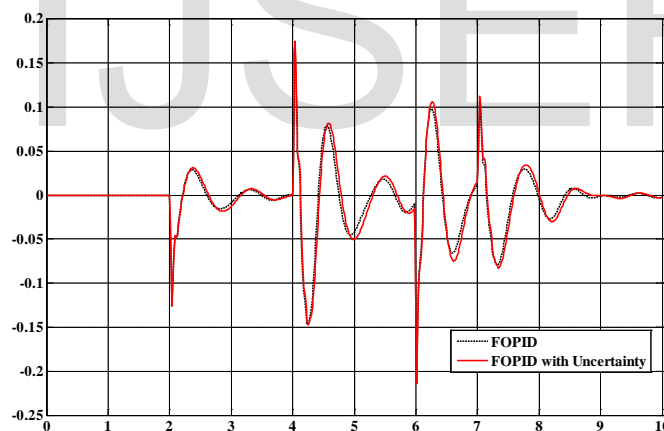

Figure10: reply of the controller of fractional order with uncertainty

In figure 10, the amount of robustness of this controller is shown with uncertainty. Uncertainty of 10% is applied on M_{WR} and M_{SR} . The system reply shows that this designed controller has a perfect performance against uncertainty. This feature is one of the most important characteristics of controllers of fractional order.

6- Conclusion

In this article the genetic algorithm is applied to design the optimized controller FOPID to control active suspension system of the vehicle. The performance of active system comparing to inactive system shows the superiority of this system that can attract engineer' attention. On the other hand, the optimized controller FOPID designed for this system has a suitable response with non-linear hydraulic actuator that could provide the comfort for the passengers to a high extent and reduce the acceleration on the body of the vehicle. It is hoped that these systems can be used in the car manufacturing industries in future.

[1] Lane R.Miller, 1988, "Tuning Passive, Semi-active, and fully active suspension systems", Proceedings of the 27th conference on Decision and Control.

[2] R. Rajamani, J. k. Hedrick, 1994, "Performance of active automotive Suspensions with hydraulic actuators", Proceedings of the American Control Conference, pp.1214-1218,

[3] R, Rajamani, J. K. Hedrick, 1995, "Adaptive observers for active automotive suspensions", IEEE Trans. on Control systems Technology, Vol 3. No. 1, pp. 86-93.

[4] A. Alleyne, J. K. Hedrik, 1995, "Nonlinear adaptive Control of active suspensions", IEEE Trans, an Control systems Technology, Vol. 3. No. 1. pp. 94-101.

[5] Niklas karlsoon, Mohammand Dahleh, Davor Hrovat, June 2001, "Nonlinear Hoo Control of active suspensions", Proceedings of the American Control Conference, pp.3329-3334.

[6] Takanori Fukao, Akira Yamawaki, Norihiko Adachi, Dec1999, "Nonlinear and Hoo control of active suspension systems with hydraulic actuator", Proceedings of the 38th conference on Decision & Control, pp.5125-5128.

[7] H. E. Merritt, 1967 "Hydraulic control systems", New York:Wiley.

[8] Tabari, Mehdi Yousefi, and Ali Vahidian Kamyad. "Design optimal Fractional PID controller for DC Motor with Genetic Algorithm." International Journal of Scientific & Engineering research Volume 3, Issue 12, December-2012

[9] Changizi, Nemat, and Modjtaba Rouhani. "Comparing PID and fuzzy logic control a quarter car suspension system." The Journal of Mathematics and Computer Science 2.3 (2011): 559-564.

[10] Lin, J. K., et al. "Integral sliding mode control and its application on Active suspension system." Power Electronics Systems and Applications (PESA), 2011 4th International Conference on. IEEE, 2011.

[11] Hrovat, Davor, et al. "The development of model predictive control in automotive industry: A survey." Control Applications (CCA), 2012 IEEE International Conference on. IEEE, 2012.

IJSER